



Read this Owner's Manual thoroughly before operating the equipment. Keep it with the equipment at all times. Replacements are available from TSE, PO Box 347, Winona, MN 55987, 507-454-2996. www.thernstage.com

IMPORTANT: Please record product information on page 2. This information is required when calling the factory for service.

ORIGINAL TEXT



Owner's Manual

For 8XFS Controls

Two-Year Limited Warranty

Please record the following:

Date Purchased: _____

Model No.: _____

Serial No.: _____

This information is required when calling the factory for service.

Thern, Inc. warrants its products against defects in material or workmanship for two years from the date of purchase by the original using buyer, or if this date cannot be established, the date the product was sold by Thern, Inc. to the dealer. To make a claim under this warranty, contact the factory for an RGA number. The product must be returned, prepaid, directly to Thern, Inc., 5712 Industrial Park Road, Winona, Minnesota 55987. The following information must accompany the product: the RGA number, the date of purchase, the description of the claimed defect, and a complete explanation of the circumstances involved. If the product is found to be defective, it will be repaired or replaced free of charge, and Thern, Inc. will reimburse the shipping cost within the contiguous USA.

This warranty does not cover any damage due to accident, misuse, abuse, or negligence. Any alteration, repair or modification of the product outside the Thern, Inc. factory shall void this warranty. This warranty does not cover any costs for removal of our product, downtime, or any other incidental or consequential costs or damages resulting from the claimed defects. This warranty does not cover brake discs, wire rope or other wear components, as their life is subject to use conditions which vary between applications.

FACTORY AUTHORIZED REPAIR OR REPLACEMENT AS PROVIDED UNDER THIS WARRANTY IS THE EXCLUSIVE REMEDY TO THE CONSUMER. THERN, INC. SHALL NOT BE LIABLE FOR ANY INCIDENTAL OR CONSEQUENTIAL DAMAGES FOR BREACH OF ANY EXPRESS OR IMPLIED WARRANTY ON THIS PRODUCT. EXCEPT TO THE EXTENT PROHIBITED BY APPLICABLE LAW, ANY IMPLIED WARRANTY OF MERCHANTABILITY OR FITNESS FOR A PARTICULAR PURPOSE ON THIS PRODUCT IS LIMITED IN DURATION TO THE DURATION OF THIS WARRANTY.

Some states do not allow the exclusion or limitation of incidental or consequential damages, or allow limitations on how long an implied warranty lasts, so the above limitation or exclusion may not apply to you. This warranty gives you specific legal rights, and you may also have other rights which vary from state to state.

Note: Thern, Inc. reserves the right to change the design or discontinue the production of any product without prior notice.

About This Manual

The Occupational Safety and Health Act of 1970 states that it is the employer's responsibility to provide a workplace free of hazard. To this end, all equipment should be installed, operated, and maintained in compliance with applicable trade, industrial, federal, state, and local regulations. It is the equipment owner's responsibility to obtain copies of these regulations and to determine the suitability of the equipment to its intended use.

This Owner's Manual, and warning labels attached to the equipment, are to serve as guidelines for hazard-free installation, operation, and maintenance. They should not be understood to prepare you for every possible situation.

Information contained in this Owner's Manual is applicable only to the Thern Model 8XFS Controls. Do not use this manual as a source of information for any other equipment.

The following symbols are used for emphasis throughout this manual:

▲WARNING

Failure to follow 'WARNING!' instructions may result in equipment damage, property damage, and/or serious personal injury.

▲CAUTION

Failure to follow 'CAUTION!' instructions may result in equipment damage, property damage, and/or minor personal injury.

Important!

Failure to follow 'Important!' instructions may result in poor performance of the equipment.

1.1 Overview

1.1.1 PHYSICAL CONTROL LAYOUT

The rigging system is controlled by the operator from a mobile touch screen pendant. The pendant has several features along with user levels to allow operators to safely move all of the motorized linesets installed. Figures 1 and 2 identify the various parts of the pendant.

E-STOP BUTTON: immediately stops travel of all motorized equipment in the system and removes power.

POWER INDICATOR: indicates the pendant is on.

GO BUTTON (F10 and OP): momentary push button that is used to initiate any movement of motorized equipment in the system.

ON/OFF KEY SWITCH: Turns the pendant on and off.

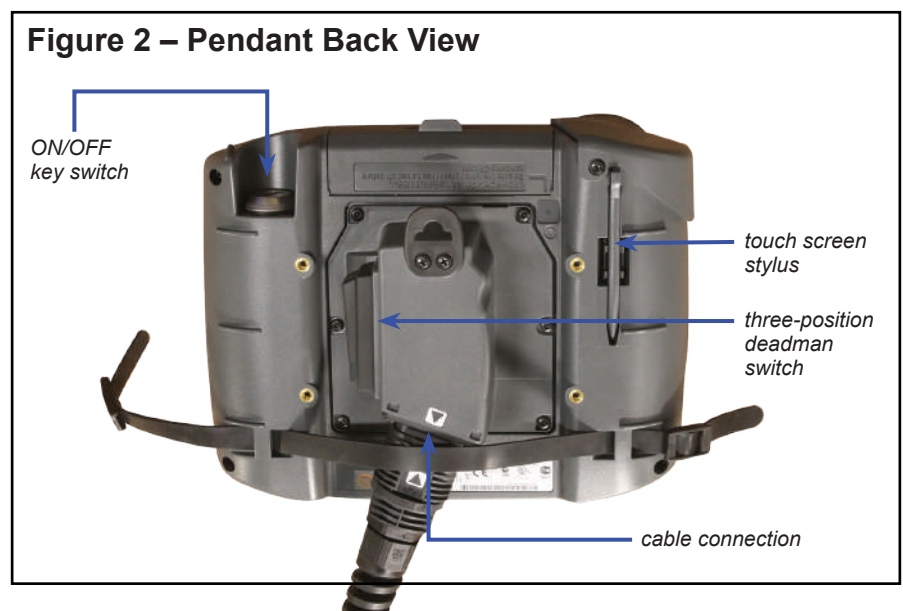
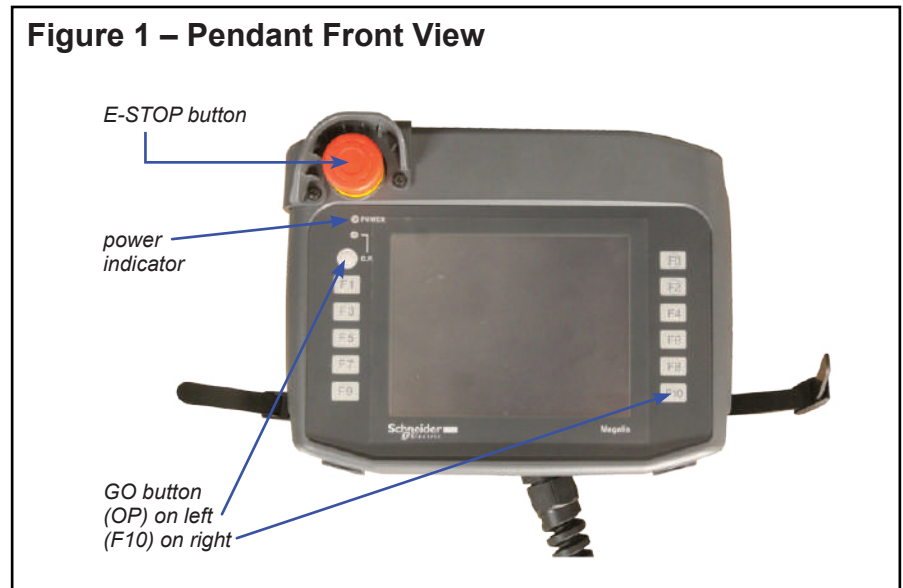

TOUCH SCREEN STYLUS: removable stylus that can be used for data entry or button selection on the touch screen.

THREE POSITION DEADMAN SWITCH: Switch that must be squeezed and held during operation of motorized equipment. If the switch is squeezed too hard or released, it will halt operation of motorized equipment.

CABLE CONNECTION: Port on the pendant for connection of cable to the base station.

1.2 Operation: Getting Started

- 1.2.1 THE TOUCH SCREEN PENDANT is connected to the motor control system through a cable with quick coupling connectors. The connectors on the cable ARE NOT interchangeable nor reversible.
- a Plug the corresponding ends of the cable into the base station mounted to the wall and to the pendant. The connectors on each end of the cable are redundant locking.
 - b Turn the circular ring at the base of the connector and then pull the outer housing back to unlock.
 - c Once the pendant is connected to the base station, turn the key switch to the on position. The screen on the pendant will display the start up sequence as the computer boots up. Once it has completed the boot sequence, the Login Screen will be displayed.
- 1.2.2 LOGIN SCREEN. At start-up of the pendant, the login screen (Figure 3) will be displayed.

Figure 3 – Log In Screen



- a Touch the button labeled LOG IN to prompt the entry for user name and password.
- 1.2.3 LOG IN POPUP SCREEN. A popup screen will appear (Figure 4). Touching the blank space next to the NAME and PASSWORD labels will pull up a keyboard for entry.
- a Enter the appropriate user name for the level of access permitted, then press the enter key on the keyboard. Repeat the same steps for entry of the respective password. The predefined user names and passwords are shown in Sect. 2.1 User Names & Passwords. Program & Factory Technician passwords are provided as an addendum to this manual.

Figure 4 – Log In Popup Screen

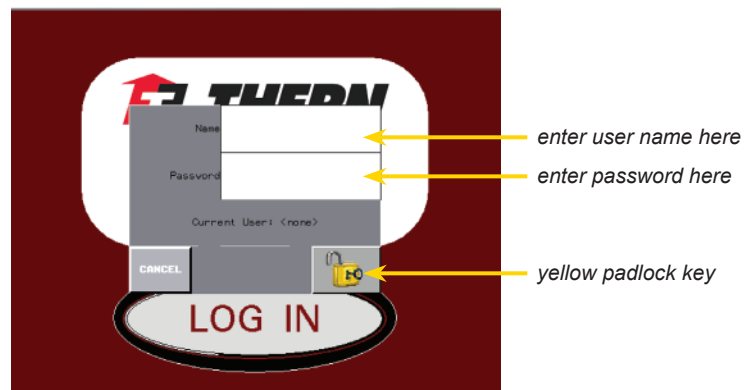

- b Touch on the yellow padlock to proceed with login to the control system.
- 1.2.4 USER LEVELS — There are three levels of users for the system: USER, PROGRAM and FACTORY TECHNICIAN.
- a USER level is the most restricted. An operator can recall a preset and operate one or more linesets to one of the pre-programmed preset positions.
 - b PROGRAM level has the same rights as the USER and has the additional ability to program the preset target positions for the linesets. The PROGRAM level is required for advanced functions such as Over-travel Bypass and Fault resetting. All of these topics will be discussed and defined later in this manual.
 - c FACTORY TECHNICIAN level has the same rights as PROGRAM and allows for the setup and calibration of the system. The FACTORY TECHNICIAN level should only be accessed by factory authorized personnel.

ACCESS AND MODIFICATION OF SETTINGS BY NON-AUTHORIZED INDIVIDUALS COULD RESULT IN INJURY AND/OR DEATH AS WELL AS PROPERTY DAMAGE.

- 1.2.5 INVALID USER NAME OR PASSWORD ENTERED — If an incorrect username or password is entered, a message in a black box at the bottom of the screen will pop up to notify the operator that re-entry of the information is required. See Figure 5.

To close the pop up, click on the gray box with an X and then re-enter the user name and password.

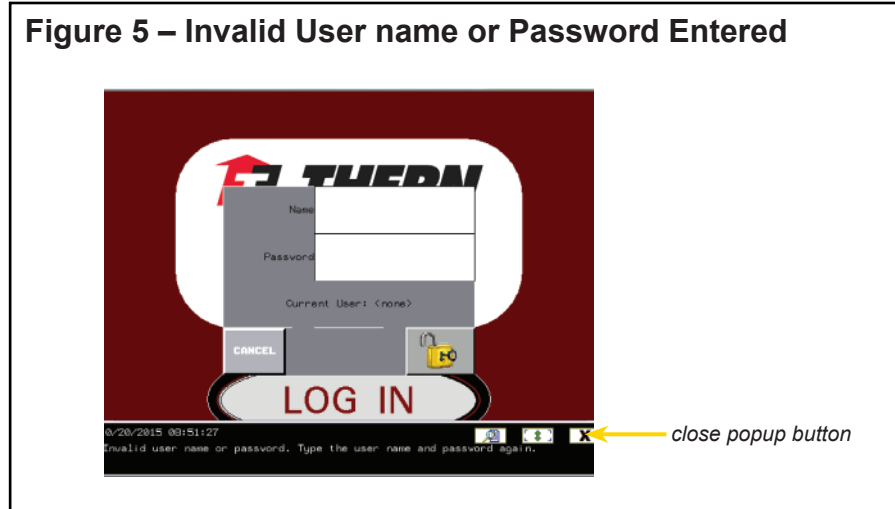

- 1.2.6 USER LEVEL OPERATION

Upon successful login, the first page that appears is the Lineset page. Figure 6 illustrates the Lineset page when logged in as USER. Each lineset has its own tab with functions specific to that lineset.

The display shows the current position of each lineset in the row labeled CURRENT.

The Target position currently selected for each lineset will be displayed in the row labeled TARGET along with the target name, if it has been defined.

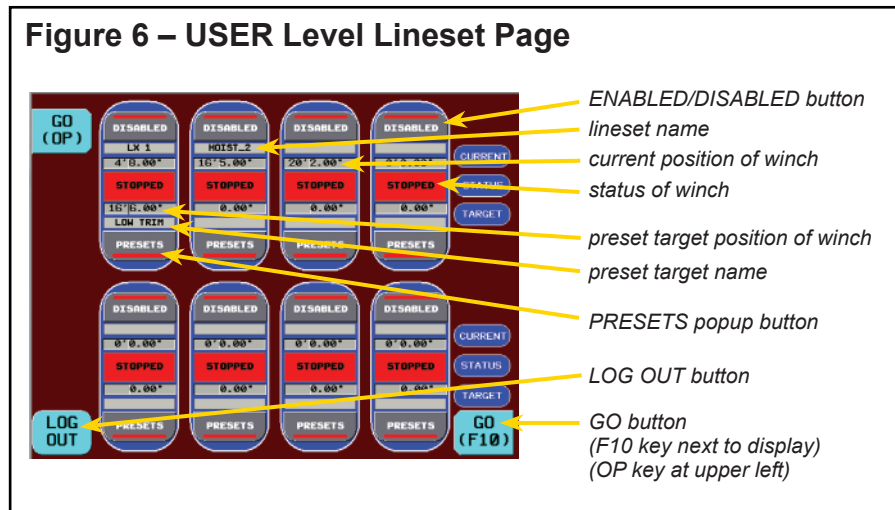

1.3 Operation Overview

- 1.3.1 STATUS INDICATOR — The current status of each lineset is displayed in the middle of each tab in the row labeled STATUS. See Table 1.

There are 8 different states that can be displayed depending on the position, preset target, motor starter condition and movement. In certain instances, the lineset will need to be reset to clear the status and allow continued operation. Resetting of the lineset requires a PROGRAM level login and will be discussed later.

- a E-STOP
In the event that an E-stop is struck, a popup will appear and identify which E-stop button was depressed (Figure 7). Once the cause for the E-stop is determined and rectified, the system can be reset.

TO RESET, first return the E-stop button to the neutral position. The message display on the screen will change from the E-stop identification to a green reset button (Figure 8). Touch the RESET button on the screen to restore the system.

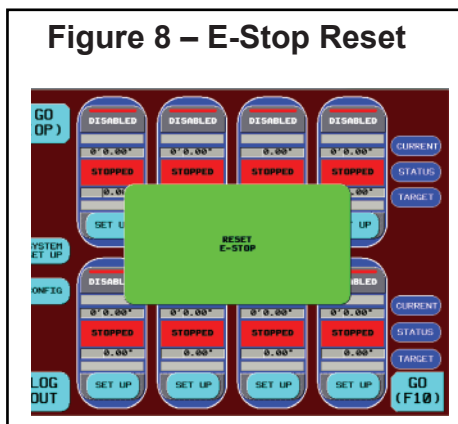
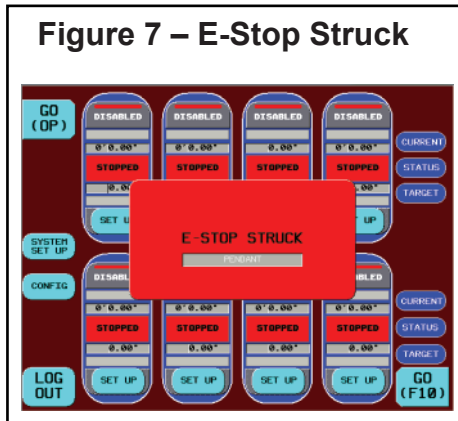

- 1.3.2 EXITING/LOGGING OUT

Press the LOG OUT button in the lower left corner of the Lineset page (Figure 6). This will return the system to the login page. The system can either be turned off by the key switch or another user can enter credentials to log in to the system.

If the controller is left on for 15 minutes with no activity, the pendant goes into a safe mode.

TO EXIT SAFE MODE AND USE THE SYSTEM, turn the key switch to the OFF position, then turn it back on to reboot.

Table 1 — Status Indicators

Status Label	Status Color	Definition	Reset Required
STOPPED	Red	Lineset is stopped, but not at the preset target.	No
RUNNING UP	Flashing Lt. Blue	Lineset is moving in the up direction.	No
UP LIMIT	Red	Lineset is stopped at the up soft limit	No
AT TARGET	Black	Lineset is stopped at the preset location.	No
RUNNING DOWN	Flashing Green	Lineset is moving in the down direction.	No
DOWN LIMIT	Red	Lineset is stopped at the down soft limit.	No
SLACK / XGROOVE	Red	A lift line has either jumped a groove or has gone slack.	Yes
FAULTED	Red	Motor starter has faulted.	Yes
LIMIT FAIL	Red	One of the mechanical end of travel limits has failed.	Yes
E-STOP	Red	An E-STOP button has been depressed.	No

1.4 Moving a Lineset

A lineset can be either chosen for manual JOG operation or selection of a preset by touching the PRESETS button under the appropriate lineset. A login of USER or higher is required to move a lineset.

A popup screen will appear when the PRESETS button of a specific lineset is selected (Figure 9). From the popup window, the operator can select one of four preset targets or can use the JOG buttons to manually move the lineset. The popup display also shows the current actual position and status of the lineset.

TO JOG THE LINESET, touch either the JOG UP button or the JOG DOWN button based upon the direction of desired movement. When selected, the indicator color on the selected JOG button will turn green.

TO INITIATE MOVEMENT, squeeze the deadman switch on the back of the pendant to the middle position and depress the GO button (F10 or OP).

TO STOP, release the GO button.

To close the popup, touch the X in the top right corner of the popup window.

TO SELECT A PRESET TARGET for the lineset to run to, touch the desired SELECT button under the preset number. The target location of each preset is displayed under each button. Once selected, the popup window will close automatically. Repeat the same steps to load preset positions for any or all other linesets.

The desired preset position(s) of the lineset(s) will be displayed in the TARGET row of each lineset on the Lineset page.

TO MOVE A LINESET TO THE DESIRED TARGET POSITION, touch on the button labeled DISABLED for the specific lineset to be moved. Once the button has been touched, the indicator light on the button will change from red to green and the label will change to ENABLED. See Figure 6.

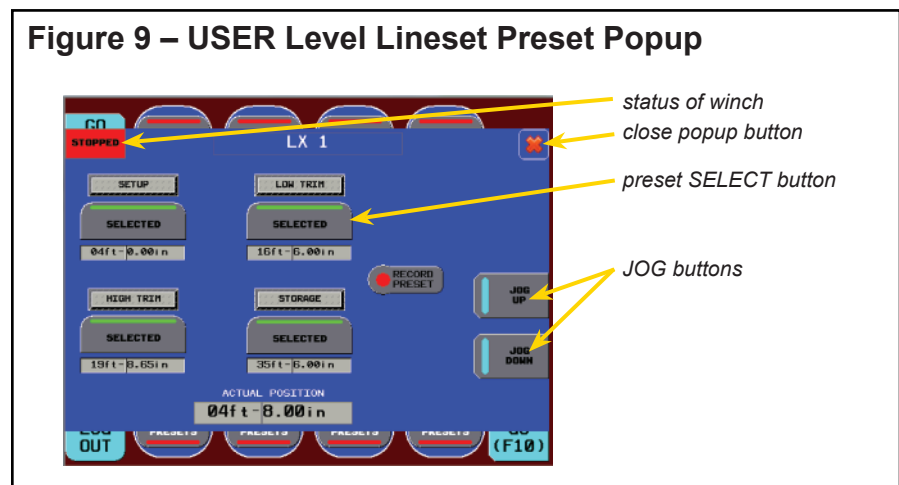

The system is configured to allow a preset number of linesets to be moved simultaneously. Once the maximum number of linesets are selected, the ENABLED/DISABLED buttons for remaining hoists are hidden.

TO ENABLE ANOTHER HOIST, one of the currently enabled hoists needs to be disabled.

Once movement of the lineset is complete, the lineset can be disabled by touching the ENABLED button of the specific lineset (Figure 10). Linesets are automatically disabled when navigating to the PRESET screen of another lineset or by logging out.

TO INITIATE MOVEMENT, squeeze the deadman switch on the back of the pendant to the middle position and depress the GO button (F10 or OP). All ENABLED linesets will move towards the respective preset selected. The lineset(s) will automatically stop when the target position is reached. The operator can also release the GO button to stop movement at any time.

⚠WARNING

WHEN RUNNING MORE THAN ONE LINESSET AT A TIME, THE DIRECTION OF TRAVEL MAY BE DIFFERENT FROM LINESSET TO LINESSET BASED ON CURRENT POSITION AND SELECTED TARGET PRESET. GREAT CARE SHOULD BE TAKEN DURING OPERATION TO PREVENT SERIOUS INJURY AND/OR DAMAGE TO PROPERTY.

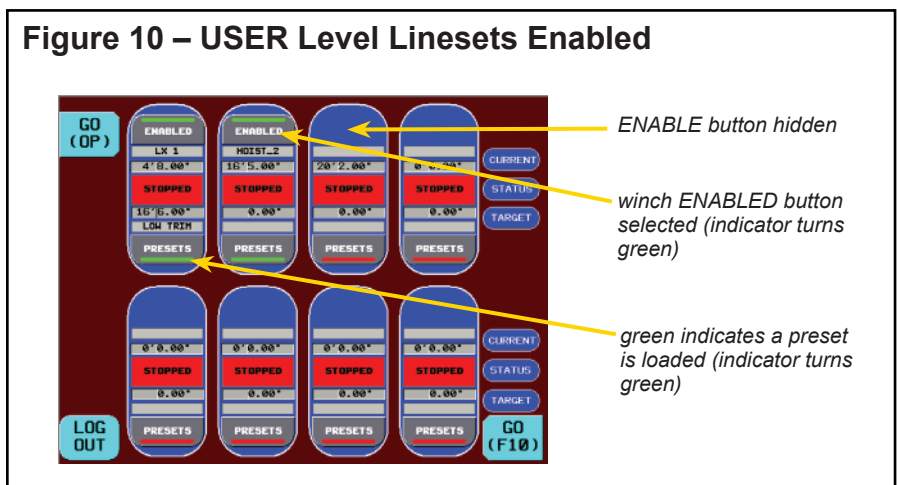

1.5 Recording Presets

TO ACCESS AND RECORD PRESETS, the operator must log into the system as a PROGRAM level user or higher. Once logged in, the user can record and modify.

1.5.1 RECORDING PRESET POSITIONS FOR LINESETS. Each of the linesets has four programmable presets.

The PROGRAM Level allows for editing and updating of the positions for each of the preset targets.

TO RECORD OR EDIT A PRESET, navigate to the Presets popup by touching the PRESETS button under the corresponding lineset.

TO RECORD A POSITION AS A PRESET, jog the lineset to the desired position. Once at the desired position, touch the RECORD PRESET button to activate the record function (Figure 11). The Preset Name can be edited by touching the name of the desired preset.

TO COMPLETE THE RECORD FUNCTION, touch RECORD button of the desired preset. This will record the current position of the lineset, the current name of the preset and exit the record function.

TO EXIT THE RECORD FUNCTION without making any changes, touch the RECORD PRESET button.

Figure 11 – Record Preset Display

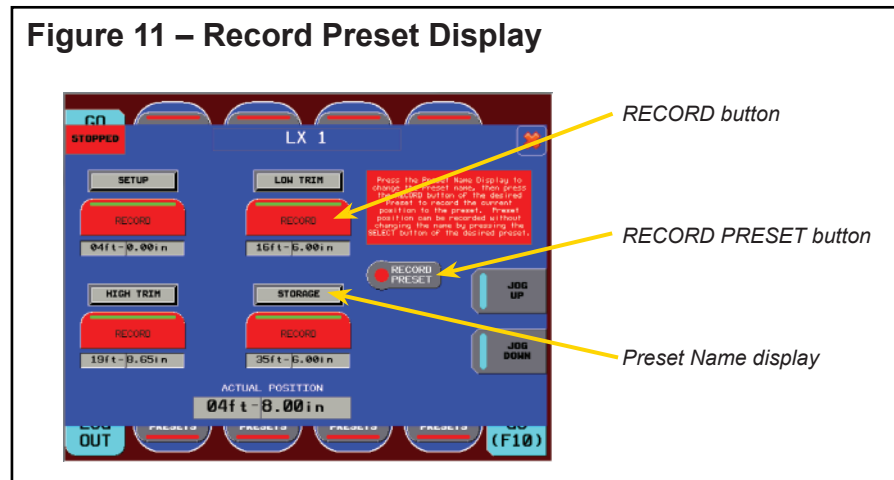

1.6 Fault Acknowledgement

TO ACCESS FAULT ACKNOWLEDGEMENT and reset Over-Travel Bypass functions, the operator must log in to the system as a PROGRAM level user or higher. Once logged in, the user can acknowledge and reset faults on the linesets and operate the over-travel limit bypass.

1.6.1 ACKNOWLEDGE AND RESET FAULTS

In the event that a lineset registers a fault with the motor starter, a slack line condition occurs or an end-of-travel hard limit fails, an acknowledgement and reset of the lineset is required. A fault can be caused by several things such as an overload condition of the lineset or repetitive plugging of the lineset.

Most faults can be reset from the controls to provide temporary operation of the system until a technician is able to examine the equipment and determine the cause of the issue.

TO RESET A FAULT OF A LINESET, touch the PRESETS button of the corresponding lineset.

In the event of a fault, a yellow RESET FAULT button will be visible in the lower left of the popup window next to a status indicator for the hoist. Touch the RESET FAULT button to reset the fault.

The status indicator should change to STOPPED once it resets, unless the line set is at the target position. If it is at the target position, the indicator will read AT TARGET.

IF THE LINESET DOES NOT RESET IMMEDIATELY, the lineset may need service by a qualified technician.

1.6.2 OVER-TRAVEL BYPASS

In the event that an end-of-travel hard limit for a lineset fails, and an over-travel limit is struck, the lineset will cease operation immediately and will no longer be operable from the standard menus.

⚠WARNING

If the lineset faults, a service technician should be called to investigate the cause. Continued operation after a fault without an inspection could cause serious personal injury and or damage to property.

Once the failure of the limit has been determined and corrected, the lineset can be moved by engaging the OVER-TRAVEL BYPASS BUTTON. The OT Bypass Button is located on the Presets Screen for each respective hoist. Once engaged, the bypass will stay in effect for 60 seconds, then reset to normal operation.

1.7 Setup and Calibration

1.7.1 ACCESSING SETTINGS

The setup and calibration of the control system is required prior to operation of the linesets from the touchscreen. To access these settings, the operator needs to be logged in at the FACTORY TECHNICIAN level. Once logged in, the screen will look similar to Figure 12.

Figure 12 – Factory Technician View (Linesets Page)

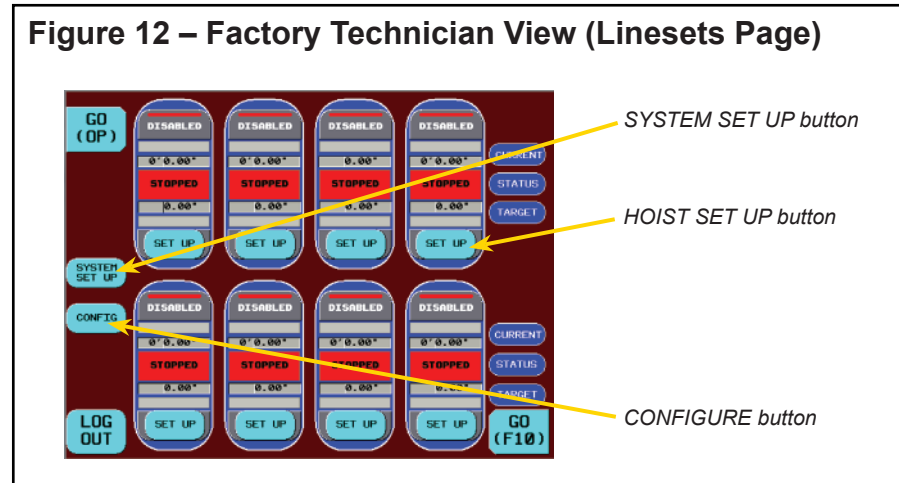

1.7.2 SYSTEM SET UP

Touch the SYSTEM SET UP button on the left side of the display to access the System Setup Screen (Figure 13). The configuration of the E-stops, units, quantity of hoists, number of hoists to operate at once and user management are all done from this screen.

Figure 13 – System Setup Screen

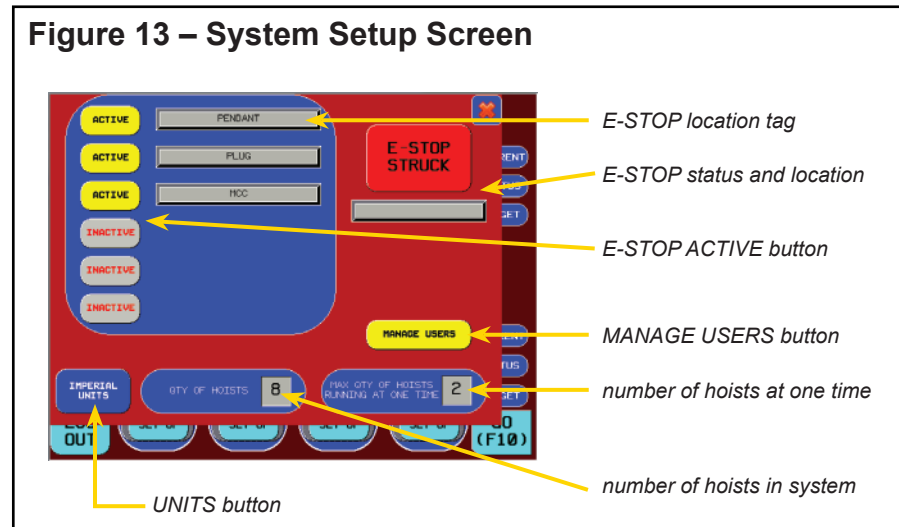

The system is designed to accept up to 6 E-stop locations. Refer to the electrical drawings for the specific project to determine the quantity and location of the E-stops for the installation. Touch the E-STOP ACTIVE button to include the input or set to inactive to bypass the input. If active, the E-STOP LOCATION TAG will become visible.

The Location name can be edited by touching on the display. A keyboard will pop up to allow entry. The system can be tested by depressing each of the E-STOPS in the system one by one and noting if the correct location is displayed in the E-STOP STATUS AND LOCATION display.

DISTANCE FEEDBACK is available in Imperial and Metric. Touch the UNITS button to toggle between the two.

THE QUANTITY OF HOISTS IN THE SYSTEM is set by touching the numeric display and entering the quantity. Up to 8 hoists can be added to the system.

THE NUMBER OF HOISTS ALLOWED TO RUN AT THE SAME TIME can be set by touching the numeric display and entering the quantity. Care should be taken to ensure suitable procedures and equipment are in place to monitor all potential moving equipment at all times.

User names and passwords can be set up and changed by touching the MANAGE USERS button.

1.7.3 HOIST SETUP

The Hoist Setup screen is used to test the hard limits, calibrate unit scaling, set software limits, set position, name the lineset, and adjust position tolerance. Instructions for performing each of these functions is provided through a multi-page instruction set on the right of the screen. Navigation from page to page is done using the UP and DOWN arrows adjacent to the text box. See Figure 14.

Set all hard limits of the hoist per the hoist owner's manual. Once limits are set, test functionality of the limits by pressing the TEST LIMITS button below. Trigger each limit manually to confirm the correct limit and wiring. The indicator light of the respective limit will turn green when it is struck.

Once the hard limits are tested, jog the hoist down until it reaches the End of Travel Down Limit.

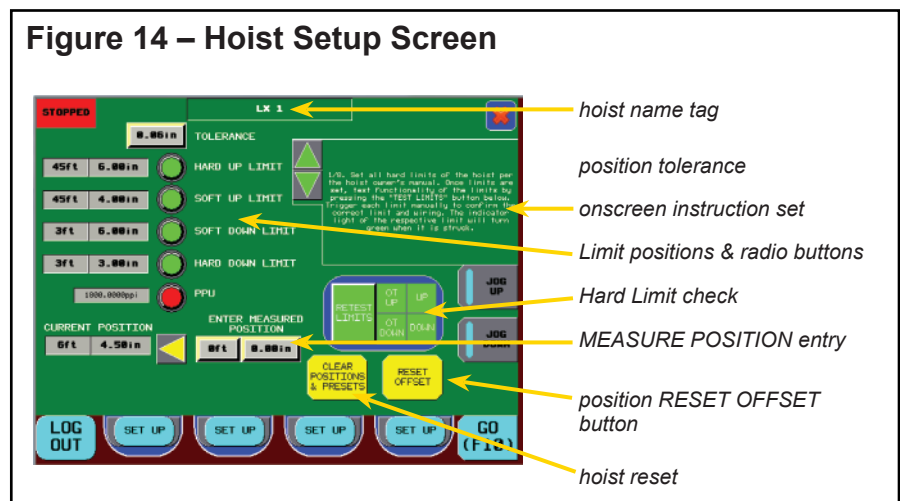

Jogging is accomplished by touching the JOG UP or the JOG DOWN button on the screen to select direction and then holding the deadman switch while pressing the OP button below the E-Stop or the F10 key at the lower right corner of the screen.

- a THE HARD DOWN LIMIT radio button will change from red to green when the limit is struck.

Measure the actual position of the batten or other lifting medium. Enter this value in the MEASURED POSITION box by touching on the display.

- If the system is in meters, there is a single entry.
- If the system is in Imperial, the feet and inches are separate entries.

A keypad will pop up to allow entry. Once the value is entered, touch the Hard Down Limit radio button. This will load the measured position into the Hard Down Limit display.

Jog the hoist up until it reaches the End of Travel Up Limit.

- b THE HARD UP LIMIT radio button will change from red to green when the limit is struck.

Measure the actual position of the batten or other lifting medium. Enter this value in the MEASURED POSITION by touching on the display.

- If the system is in meters, there is a single entry.
- If the system is in Imperial, the feet and inches are separate entries.

A key pad will pop up to allow entry into the respective locations. Once the value is entered, touch the Hard Up Limit radio button. This will load the measured position into the Hard Up Limit display.

ONCE BOTH HARD LIMITS HAVE BEEN SET, touch the PPU radio button to set the measurement scale.

- The PPU will display 1000 if the units are Imperial and has not been calibrated.
- The PPU will display 3000 if the units are Metric and has not been calibrated.

A display of 1234 means that the Hard Up Limit has been set below the Hard Down Limit. This is an indication that either the hoist was operated backwards during setup or the encoder is wired in reverse.

- c Set the CURRENT POSITION by entering the current measured position into the MEASURED POSITION display.

- If the system is in meters, there is a single entry.
- If the system is in Imperial, the feet and inches are separate entries.

A key pad will pop up to allow entry into the respective locations. Once the measured distance is entered, touch the yellow arrow button between the CURRENT POSITION display and the ENTER MEASURED POSITION display. This will load the measured position into the current position.

The HOIST NAME can be changed by touching on the HOIST NAME display at the top of the screen. A keyboard will pop up to allow entry.

The SOFT LIMITS are set by entering the desired position in the MEASURED POSITION box and then touching the respective radio button for the soft limit.

The TOLERANCE is the allowable distance the actual position can be off from the target position and be considered at target.

THE TOLERANCE CAN BE SET by touching the TOLERANCE display. A key pad will pop up to allow entry. Tolerance should typically be .06"-.25"(2-6mm).

Once all settings have been completed, exit the setup screen by touching on the X in the top right corner.

1.8 Manual Operation

TO USE THE MANUAL CONTROL, touch the ENABLE button on the MCC, then press the CONTROLS HERE button. The CONTROLS HERE indicator light will illuminate. If the touchscreen pendant is still connected and on, a message will pop up to state that controls have been taken over at the MCC. Touching the message on the pendant will return the controls to the pendant.

Select the appropriate hoist for operation by turning the selector switch on the MCC and then hold either the UP button or the DOWN button based on desired movement.

Operation of the hoists from the manual control bypasses all presets and soft limits. Hoists will operate through the allowable range within the mechanical hard limits.

2.1 User Names and Passwords

Level	User Name	Password
User	USER	USER
Program	PROGRAM	
Factory Technician	FACTORY TECHNICIAN	



A division of:

Thern, Incorporated
5712 Industrial Park Road
Winona, MN 55987

PHN 800-553-2204
FAX 507-454-5282

EMAIL: info@thernstage.com
www.thernstage.com